

STA - PRO S/S UNDERMOUNT SINK

STA-PRO MFG. 43 SO. LINDEN AVE. SO. S.F., CA 94080 PH (650) 589-4231 FAX (650) 580-3981

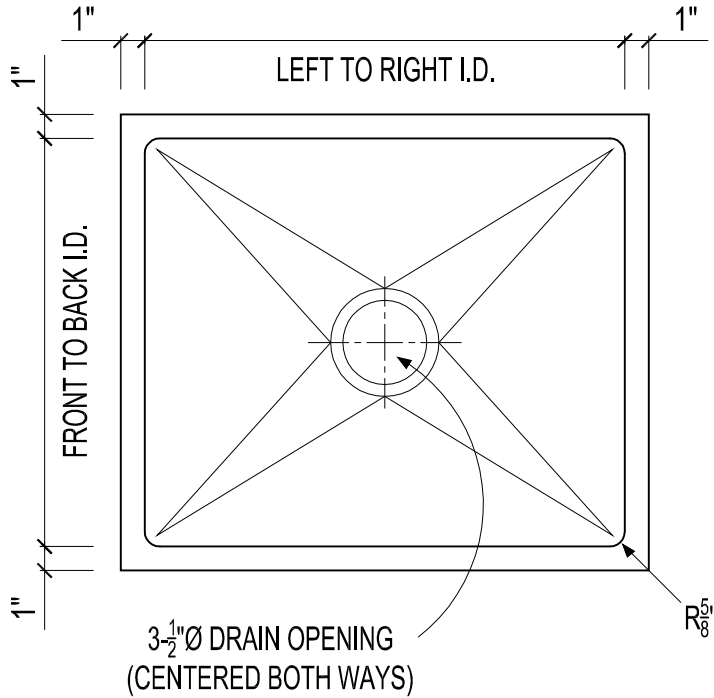

PLAN VIEW

SCALE: 1-1/2" = 1'-0"

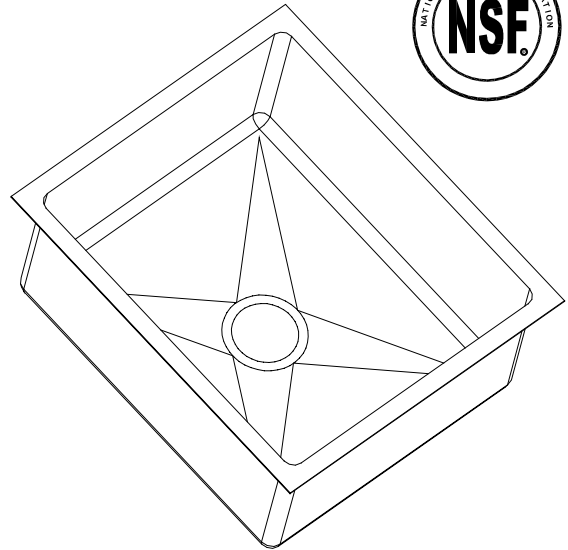

ISOMETRIC VIEW

N.T.S.

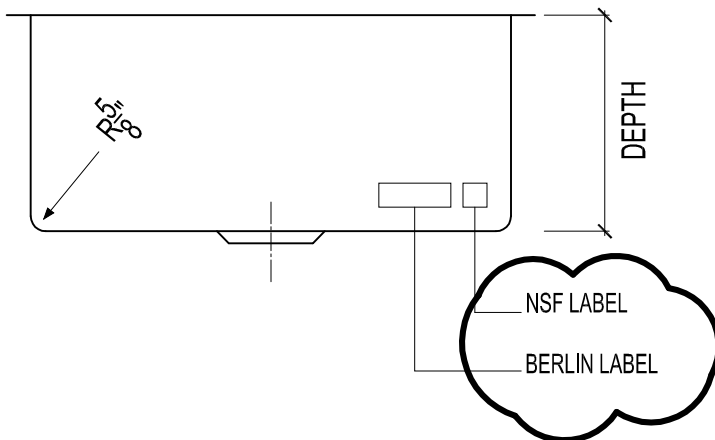
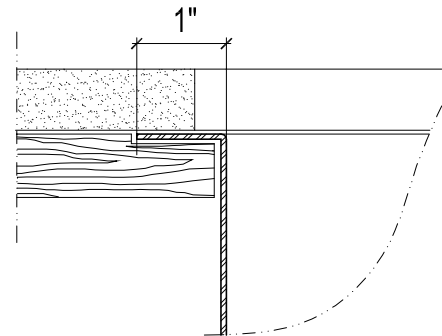

FRONT VIEW

SCALE: 1-1/2" = 1'-0"

SPECIFICATIONS:

16 GA. T-304 S/S #4
FINISH I.D., UNDERMOUNT
SINK. BUILT TO COMPLY
WITH N.S.F. STD 2

OPTIONAL:

- 3-1/2" BASKET DRAIN
- SOUND DEADENED BOTTOM